

Profiler

Hos ES Vinduet benytter vi os af vinduessystemet fra REHAU.

Vinduessystemet er designet med slanke profiler som passer godt til den nordisk/skandinaviske stil.

Materialet er et glasfiberforstærket kompositmateriale, der har en lang levetid og høj varmeisoleringssevne. Materialet bliver bl.a. brugt i fly- og formel 1 produktion. Profilerne er 100 % genanvendelige, hvilket gør dine vinduer og døre mere miljøvenlige.

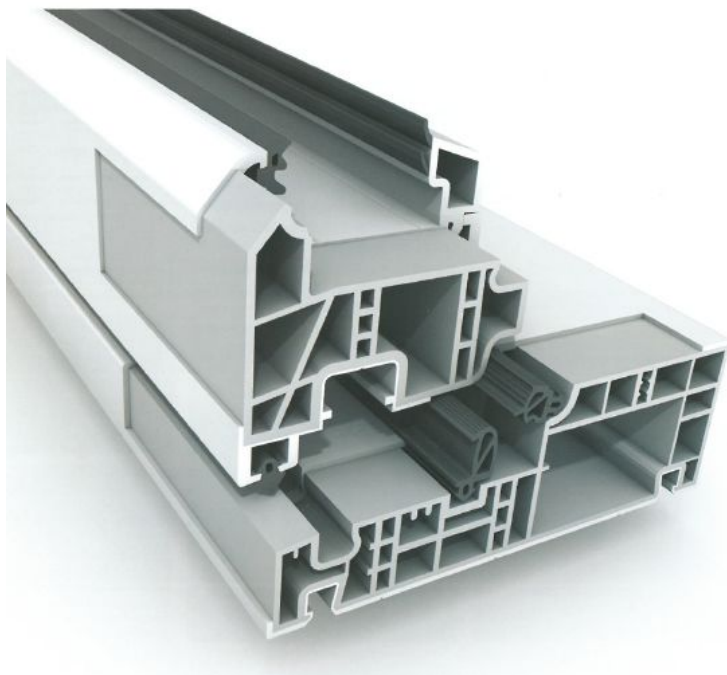

Karm og ramme med tætningslister

Nordic Design Plus produceres i karmdybde 120mm
Rammen har 6 kamre og karmen har 9.

Fordele ved REHAU profiler:

- God stabilitet
- Optimeret isoleringsevne
- Større sikkerhed mod indbrud
- Minimum vedligehold
- Slanke profiler
- Flere designmuligheder
- Miljøvenlighed

Vinduesprofil

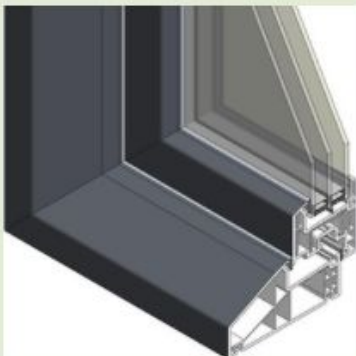

Konvektionsspærre

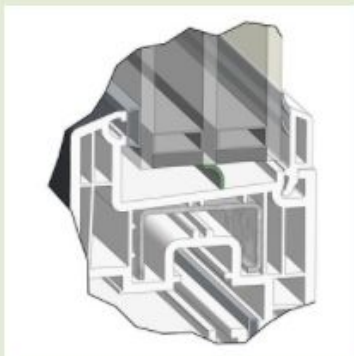

Indvendig overfladetemperatur på 15,5°

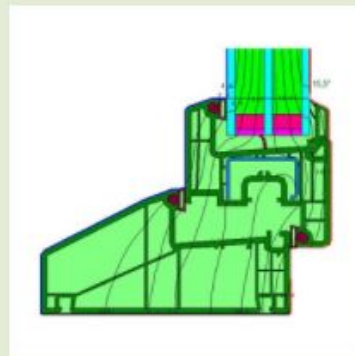

NORDIC PLUS

- Udadgående systemer

Karm

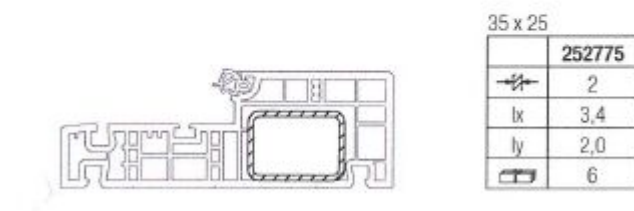
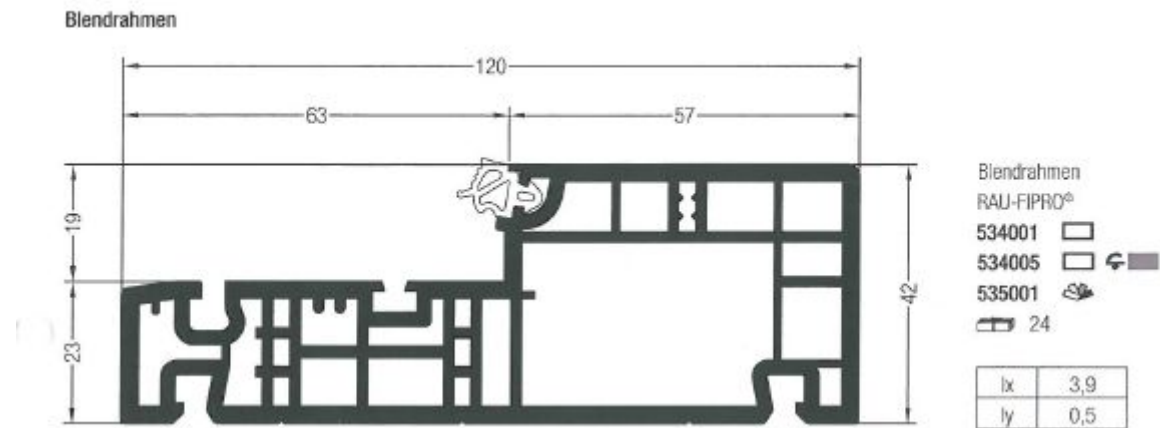

Ramme

Flügel

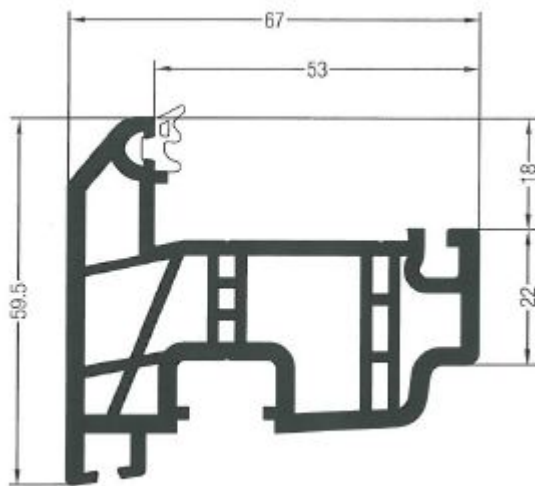

Flügel 1

RAU-FIPRO®

534011 

534015 



535011 

 24

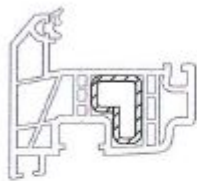
ix	0,9
ly	0,4



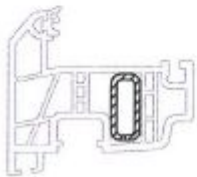

18 x 24

	353291
	2
ix	0,5
ly	0,9
	6



10,5 x 24

	355528
	2
ix	0,2
ly	0,6
	6

Post

Pfosten-Kämpfer

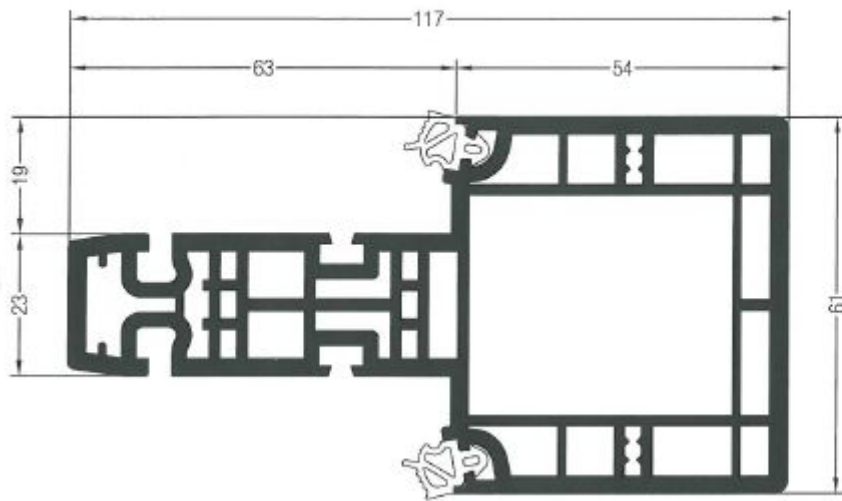

- Pfosten 117
 RAU-FIPRO®
 534021
 534025
 535021
 24

lx	4,1
ly	1,0

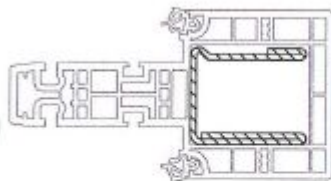

35 x 42

	238570
	2
lx	6,5
ly	6,1
	6

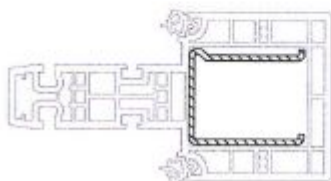

35 x 42

	350193
	2
lx	4,5
ly	4,5
	6

Ramme til Terrassedør

Balkontürlügel

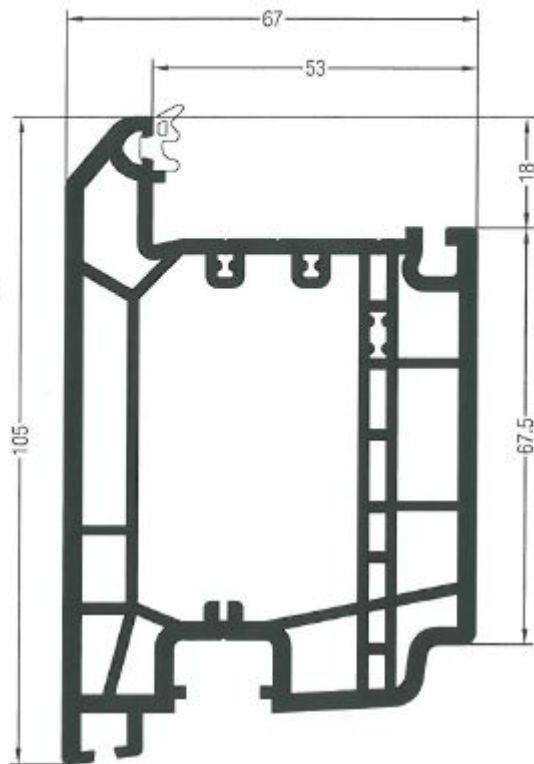

Balkontürlügel



RAU-FIPRO®

- 534061 
- 534065  
- 535061 
-  24

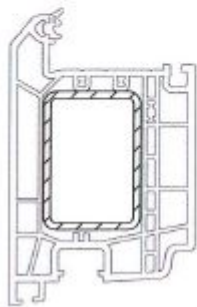
lx	1,8
ly	2,6



35 x 50

	353286
	2.5
lx	7.3
ly	12.8
	6

Ramme til Facadedør

Haustürflügel

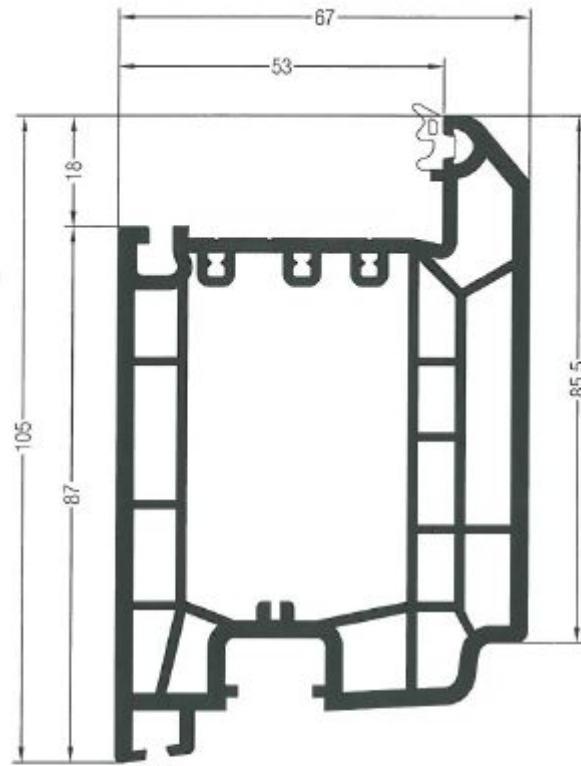

Haustürflügel

PVC

534071 

534075 

535071 

 24

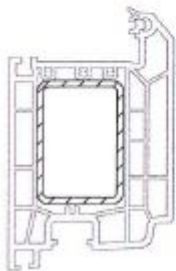

35 x 50

	353286
	2.5
lx	7.3
ly	12.8
	6

Glasdelene Sprosse

- *Bruges kun til døre*

Flügelsprossen

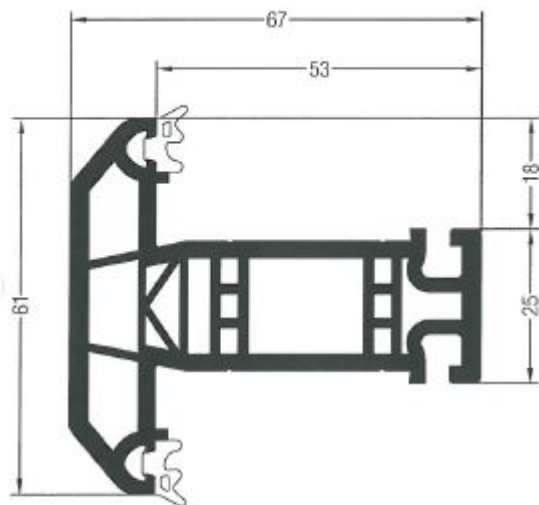

Sprosse 61

PVC

534051 



534055  

535051 

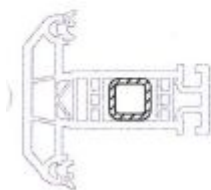
 36



15 x 15

	244035
	2
lx	0,25
ly	0,25
	6

BRILLIANT

- Indadgående systemer

Karm 70 mm

Blendrahmen

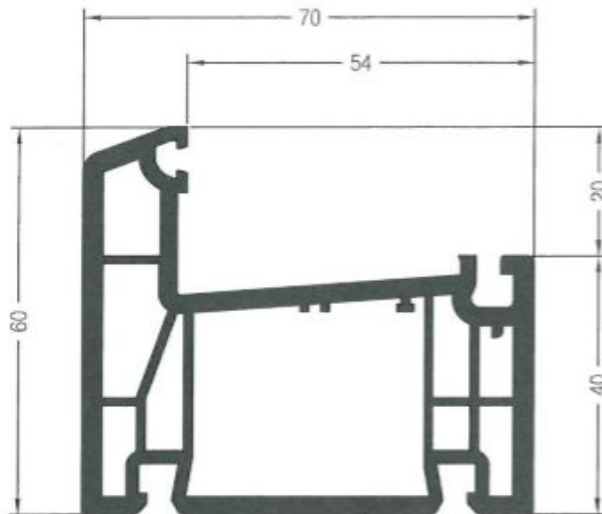

Blendrahmen 60 DK BriD

1550101

36

1550106

624

Verglasungsdichtung siehe
Verglasungsrichtlinien



	1864952
	1835171
	1865530

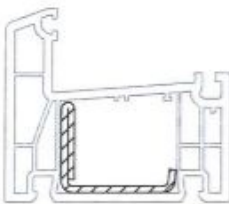

35,5 x 28

	1244546
	2
lx	2,2
ly	1,3
	6

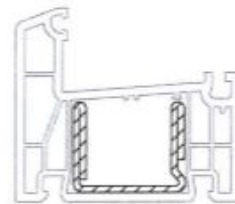

35 x 28

	1244536
	2
lx	5,0
ly	2,0
	6

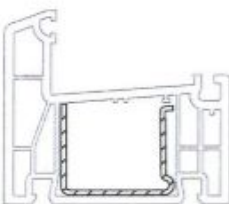

35 x 28

	1244506
	1,5
lx	2,5
ly	1,1
	6

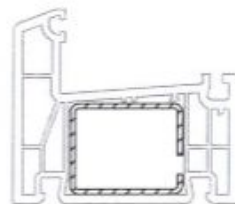

35 x 28

	1237091	1249934
	1,5	2
lx	2,8	3,4
ly	2,1	2,6
	6	6

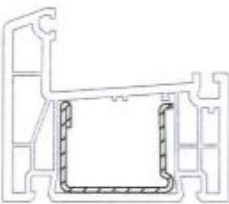

35 x 28

	1244516	1244526
	1,5	2
lx	2,7	3,5
ly	1,3	1,7
	6	6

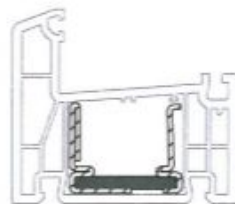

35 x 28

	1233134
	1,5
	6

Karm 120 mm

Blendrahmen

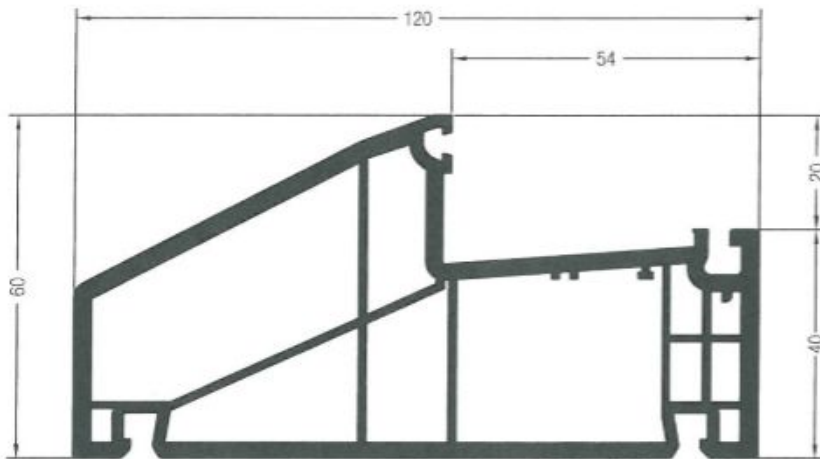



Blendrahmen 60/120 BrD

1550001 

 24

1599001  @



 12

1550006  

 264

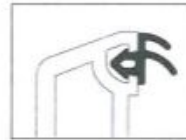

Verglasungsdichtung siehe
Verglasungsrichtlinien

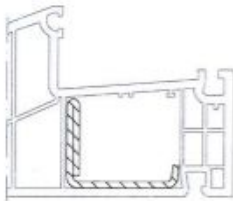

	1864952
	1835171
	1865530



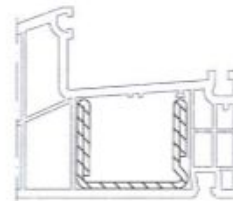

35,5 x 28

	1244546
	2
lx	2,2
ly	1,3
	6



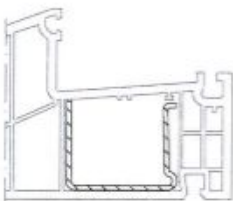

35 x 28

	1244536
	2
lx	5,0
ly	2,0
	6



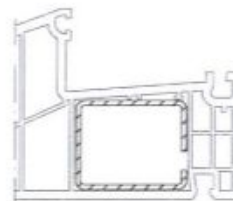

35 x 28

	1244506
	1,5
lx	2,5
ly	1,1
	6



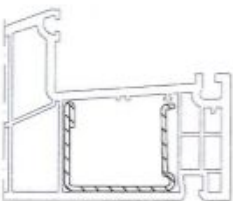

35 x 28

	1237091	1249934
	1,5	2
lx	2,8	3,4
ly	2,1	2,6
	6	6



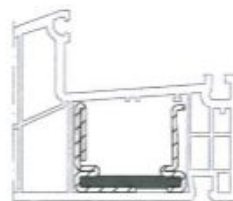

35 x 28

	1244516	1244526
	1,5	2
lx	2,7	3,5
ly	1,3	1,7
	6	6



35 x 28

	1233134
	1,5
	6

Ramme

Flügel

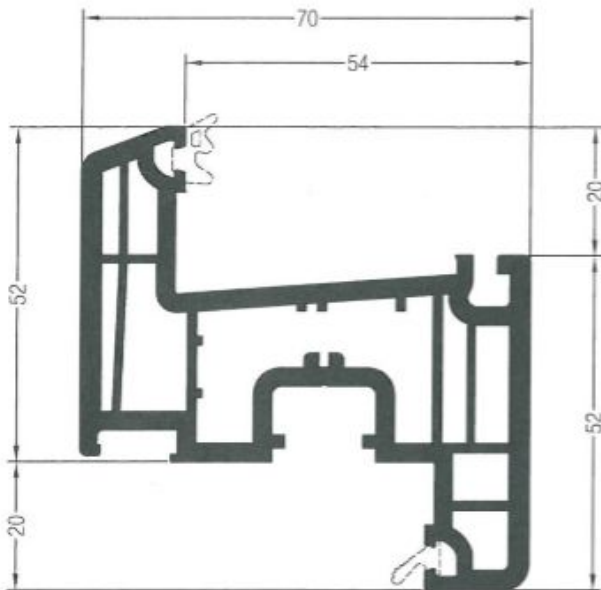

Flügel Z 52 BriD

1550480

36

1599480

24

1550485

1599485

24

Verglasungsdichtung siehe
Verglasungsrichtlinien



	1864952
	1835171
	1865530

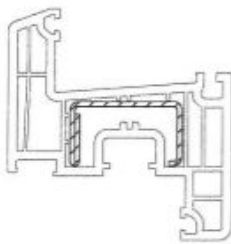

35 x 20

	1261831	1261841
	1,5	2
lx	2,5	3,1
ly	0,56	0,69
	6	6

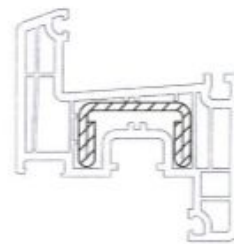

35 x 20

	1245526
	2,5
lx	4,2
ly	0,9
	6

Post

Pfosten-Kämpfer-Sprossen

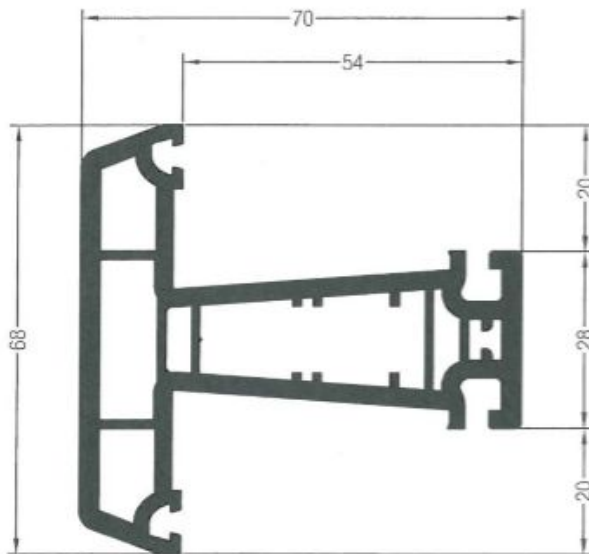

Sprosse 68 Bautiefe 70



1550030 

1599030 

 36



Verglasungsdichtung siehe
Verglasungsrichtlinien

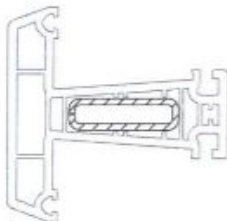

	1864952
	1835171
	1865530



35 x 10

	1261801
	2
lx	1,8
ly	0,22
	6